

# F406



**Clamp multimeter**

You have just acquired an **F406 clamp multimeter** and we thank you.

For best results from your device:

- **read** this user manual attentively,
- **observe** the precautions for its use.



WARNING, risk of DANGER ! The operator should refer to this user's manual whenever this danger symbol appears.



Application or withdrawal authorized on bare conductors carrying dangerous voltages. Type A current sensor as per IEC/EN 61010-2-032



Battery.



Equipment protected throughout by double or reinforced insulation.



Earth.



The CE marking indicates compliance with the European Low Voltage Directive (2014/35/EU), Electromagnetic Compatibility Directive (2014/30/EU), and Restriction of Hazardous Substances Directive (RoHS, 2011/65/EU and 2015/863/EU).



AC - Alternating current.



AC and DC - Alternating and direct current.











The rubbish bin with a line through it indicates that, in the European Union, the product must undergo selective disposal in compliance with Directive WEEE 2012/19/EU. This equipment must not be treated as household waste.

### Definitions of the measurement categories

- Measurement category IV corresponds to measurements taken at the source of low-voltage installations.  
Example: power feeders, meters and protection devices.
- Measurement category III corresponds to measurements on building installations.  
Example: distribution panel, circuit-breakers, machines or fixed industrial devices.
- Measurement category II corresponds to measurements taken on circuits directly connected to low-voltage installations.  
Example: power supply to domestic electrical appliances and portable tools.

# CONTENTS

<b>1. DELIVERY CONDITION</b> .....	<b>4</b>
<b>2. PRESENTATION</b> .....	<b>5</b>
2.1. The switch .....	6
2.2. The keys of the keypad .....	7
2.3. The display unit .....	8
2.4. The terminals.....	10
<b>3. THE KEYS</b> .....	<b>11</b>
3.1.  key .....	11
3.2.  key (second function) .....	12
3.3.  key .....	12
3.4.  key .....	13
3.5.  key .....	14
3.6.  key.....	14
<b>4. USE</b> .....	<b>15</b>
4.1. Commissioning .....	15
4.2. Starting up the clamp multimeter .....	15
4.3. Switching the clamp multimeter .....	15
4.4. Configuration .....	15
4.5. Voltage measurement (V).....	16
4.6. Continuity test  .....	17
4.7. Resistance measurement $\Omega$ .....	17
4.8. Diode test  .....	18
4.9. Current measurement (A).....	18
4.10. Starting current or over-current (True INRUSH) measurement .....	19
4.11. Power measurements W, VA, var and PF.....	20
4.12. "Direction of rotation of the phases" or "order of the phases" mode  .....	21
4.13. Frequency measurement (Hz).....	22
4.14. Measurement of the level of harmonics (THD) and of the frequency of the fundamental (Network).....	23
<b>5. CHARACTERISTICS</b> .....	<b>24</b>
5.1. Reference conditions.....	24
5.2. Characteristics under the reference conditions .....	24
5.3. Environmental conditions .....	32
5.4. Characteristics of construction .....	32
5.5. Power supply .....	32
5.6. Compliance with international standards.....	32
5.7. Variations in the domain of use .....	33
<b>6. MAINTENANCE</b> .....	<b>34</b>
6.1. Cleaning .....	34
6.2. Replacement of the batteries.....	34
<b>7. WARRANTY</b> .....	<b>34</b>

# PRECAUTIONS FOR USE

---

This device complies with safety standards IEC/EN 61010-1 and IEC/EN 61010-2-032 for voltages of 1 000 V in category IV and 1 500 V in category III, less than 2 000 m, indoors or outdoors, as described in § "Characteristics", with a degree of pollution not exceeding 2.

These safety instructions are intended to ensure the safety of persons and proper operation of the device. If the tester is used other than as specified in this data sheet, the protection provided by the device may be impaired.

- The operator and/or the responsible authority must carefully read and clearly understand the various precautions to be taken in use.
- If you use this instrument other than as specified, the protection it provides may be compromised, thereby endangering you.
- Do not use the instrument in an explosive atmosphere or in the presence of flammable gases or fumes.
- Do not use the instrument on networks of which the voltage or category exceeds those mentioned.
- Do not exceed the rated maximum voltages and currents between terminals or with respect to earth.
- Do not use the instrument if it appears to be damaged, incomplete, or not properly closed.
- Before each use, check the condition of the insulation on the leads, housing, and accessories. Any element of which the insulation is deteriorated (even partially) must be set aside for repair or scrapped.
- Use leads and accessories rated for voltages and categories at least equal to those of the instrument. If not, an accessory of a lower category lowers the category of the combined Clamp + accessory to that of the accessory.
- Observe the environmental conditions of use.
- Do not modify the instrument and do not replace components with "equivalents". Repairs and adjustments must be done by approved qualified personnel.
- Replace the batteries as soon as the  symbol appears on the display unit. Disconnect all cords before opening the battery compartment cover.
- Use personal protective equipment when conditions require.
- Keep your hands away from the unused terminals of the instrument.
- When handling the test probes, crocodile clips, and clamp ammeters, keep your fingers behind the physical guard.
- As a safety measure, and to avoid repeated overloads on the inputs of the device, we recommend performing configuration operations only when the device is disconnected from all dangerous voltages.

## 1. DELIVERY CONDITION

---

The **F406** clamp multimeter is delivered in its packaging box with:

- 2 banana-banana leads, one red and one black
- 2 test probes, one red and one black
- 1 black crocodile clip
- 4 1.5 V batteries
- 1 carrying bag
- 1 multilingual user guide
- 1 multilingual getting started guide.

For accessories and spares, visit our web site:

[www.chauvin-arnoux.com](http://www.chauvin-arnoux.com)



## 2. PRESENTATION

The **F406** is a professional electrical measuring instrument that combines the following functions:

- Current measurement,
- Measurement of inrush current / over current (True-Inrush),
- Voltage measurement,
- Frequency measurement,
- Measurement of level of harmonics (THD),
- Continuity test with buzzer,
- Resistance measurement,
- Diode test,
- Power measurement (W, VA, var and PF),
- Indication of the order of the phases.

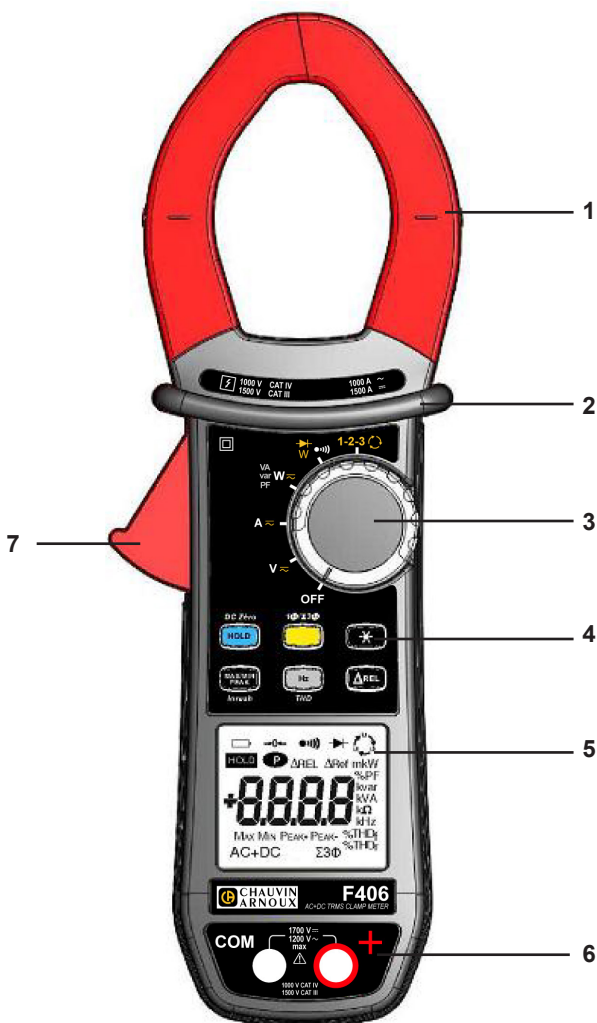

Item	Designation	See §
1	Jaws with centering marks (see connection principles)	<a href="#">4.5</a> to <a href="#">4.14</a>
2	Physical guard	-
3	Switch	<a href="#">2.1</a>
4	Function keys	<a href="#">3</a>
5	Display unit	<a href="#">2.3</a>
6	Terminals	<a href="#">2.4</a>
7	Trigger	-

Figure 1: the F406 clamp multimeter

## 2.1. THE SWITCH

The switch has six positions. To access the  $V \approx$ ,  $\Omega \bullet \bullet \bullet \bullet$ ,  $A \approx$ ,  $\frac{VA}{var PF} W \approx$ ,  $1-2-3 \text{ } \curvearrowright$ , functions, set the switch to the desired function. Each setting is confirmed by an audible signal. The functions are described in the table below:

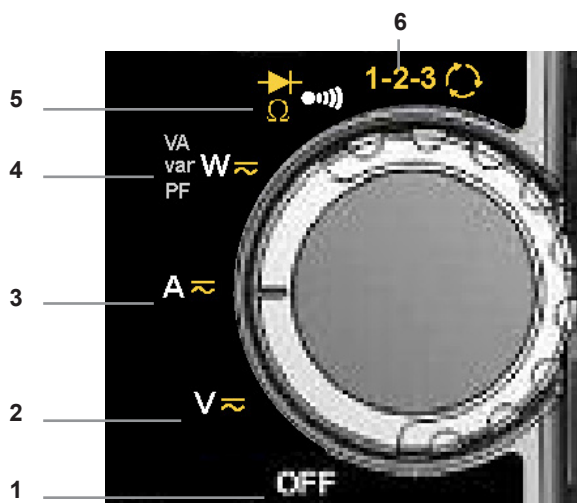

Figure 2: the switch

Item	Function	See §
1	OFF mode - Switches the clamp multimeter off	<a href="#">4.3</a>
2	AC, DC, AC+DC voltage measurement (V)	<a href="#">4.5</a>
3	AC, DC, AC+DC current measurement (A)	<a href="#">4.9</a>
4	Power measurements (W, var, VA) and calculation of the power factor (PF) AC, DC, AC+DC	<a href="#">4.11</a>
5	Continuity test $\bullet \bullet \bullet \bullet$ Resistance measurement $\Omega$ Diode test $\rightarrow  $	<a href="#">4.6</a> <a href="#">4.7</a> <a href="#">4.8</a>
6	Indicator of the order of the phases $1-2-3 \text{ } \curvearrowright$	<a href="#">4.12</a>

## 2.2. THE KEYS OF THE KEYPAD

Here are the six keys of the keypad:

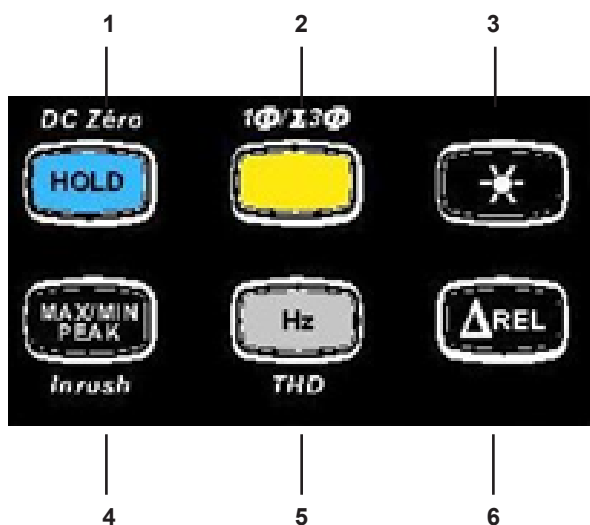

Figure 3: the keys of the keypad

Item	Function	See §
1	Storage of values, disabling of display Zero connection ADC / AAC+DC / WDC / WAC+DC Compensation of the resistance of the leads in the continuity and ohmmeter function	<a href="#">3.1</a> <a href="#">4.9.2</a> <a href="#">4.6.1</a>
2	Selection of the type of measurement (AC, DC, AC+DC) Selection of single-phase or three-phase measurement	<a href="#">3.2</a>
3	Activation or de-activation of the backlighting of the display unit	<a href="#">3.3</a>
4	Activation or de-activation of the MAX/MIN/PEAK mode Activation or de-activation of the INRUSH mode in A	<a href="#">3.4</a>
5	Measurements of frequency (Hz), of the level of harmonics (THD) Display of the powers W, VA, var and PF	<a href="#">3.5</a>
6	Activation of the ΔREL mode Display of relative and differential values	<a href="#">3.6</a>

## 2.3. THE DISPLAY UNIT

Here is the display unit of the clamp multimeter:

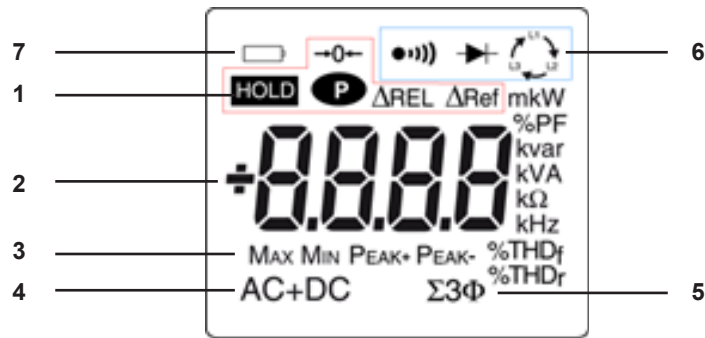





Figure 4: the display unit

Item	Function	See §
1	Display of the modes selected (keys)	<a href="#">3</a>
2	Display of the measurement value and unit	<a href="#">4.5</a> to <a href="#">4.12</a>
3	Display of the MAX/MIN/PEAK modes	<a href="#">3.4</a>
4	Type of measurement (AC or DC)	<a href="#">3.2</a>
5	Total three-phase power measurements	<a href="#">4.11.2</a>
6	Display of the selected modes (switch)	<a href="#">4.5</a>
7	Spent battery indication	<a href="#">6.2</a>

### 2.3.1. THE SYMBOLS OF THE DISPLAY UNIT

Symbol	Designation
<b>AC</b>	Alternating current or voltage
<b>DC</b>	Direct current or voltage
<b>AC+DC</b>	Alternating and direct current or voltage
<b>ΔREL</b>	Relative value, with respect to a reference
<b>ΔRef</b>	Reference value
<b>HOLD</b>	Storage of the values and hold of the display
<b>Max</b>	Maximum RMS value
<b>Min</b>	Minimum RMS value
<b>Peak+</b>	Maximum peak value
<b>Peak-</b>	Minimum peak value
<b>Σ3Φ</b>	Balanced total three-phase power measurement
<b>V</b>	Volt
<b>Hz</b>	Hertz
<b>W</b>	Watt
<b>A</b>	Ampere
<b>%</b>	Percentage
<b>Ω</b>	Ohm
<b>m</b>	Milli-prefix
<b>k</b>	Kilo-prefix
<b>var</b>	Reactive power
<b>VA</b>	Apparent power
<b>PF</b>	Power factor
<b>THD<sub>f</sub></b>	Total harmonic distortion with respect to the fundamental
<b>THD<sub>r</sub></b>	Total harmonic distortion with respect to the true RMS value of the signal
	Indicator of order to the phases
<b>→ 0 ←</b>	Compensation of the resistance of the leads
<b>●)))</b>	Continuity test
	Diode test
<b>P</b>	Permanent display (automatic switching off de-activated)
	Spent battery indicator

The display of "rdy" for "ready", indicates that the device is ready ("Indicator of order of the phases" function)

### 2.3.2. MEASUREMENT CAPACITY EXCEEDED ( O.L)

The **O.L** (Over Load) symbol is displayed when the display capacity is exceeded.

## 2.4. THE TERMINALS

The terminals are used as follows:

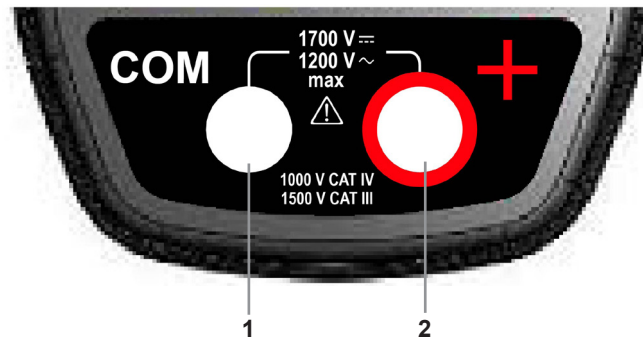

Figure 5: the terminals

Item	Function
1	Cold terminal (COM)
2	Hot terminal (+)

## 3. THE KEYS

The keys of the keypad respond differently to short, long, and sustained presses.

The **MAX/MIN/PEAK**, **Hz** and **ΔREL** keys provide new functions and allow the detection and acquisition of parameters complementary to the usual elementary measurements.

Each of these keys can be used independently of the others or in perfect complementarity with them: this makes navigation simple and intuitive for looking up all measurement results.

It is possible, for example, to look up in turn the MAX, MIN, etc. values of the RMS voltage alone, or else look up in turn all of the MAX (or MIN, or PEAK) values of all power results (W, VA, var, etc.).







In this section, the  icon represents the possible positions of the switch for which the key concerned has some action.

### 3.1. **HOLD** KEY

This key is used to:

- store and look up the last values acquired specific to each function (V, A, Ω, W) according to the specific modes previously activated (MAX/MIN/PEAK, Hz, ΔREL, THD), the present display is then maintained while the detection and acquisition of new values continues;
- perform automatic compensation of the resistance of the leads (see also § 4.6.1);
- perform an automatic zero correction in ADC/AC+DC and WDC/AC+DC (see also § 4.9.2).

**Remark:** the key is invalid for the "Indication of order of phases" function.

Successive presses on <b>HOLD</b>		... serve
short	   	<ol style="list-style-type: none"> <li>1. to stored the results of the present measurements,</li> <li>2. to hold the display of the last value displayed,</li> <li>3. to return to normal display mode (the value of each new measurement is displayed)</li> </ol>
long (> 2 sec)	ADC AAC+DC WDC WAC+DC	to perform automatic compensation of the zero (see § 4.9.2)  <b>Remark:</b> this mode operates if the MAX/MIN/PEAK or HOLD modes (short press) are first deactivated.
sustained		to perform automatic compensation of the resistance of the leads (see § 4.6.1)











See also § 3.4.2 and § 3.5.2 for the action **HOLD** key with the action of the **MAX/MIN/PEAK** key and with the action of the **Hz** key.

### 3.2. KEY (SECOND FUNCTION)

This key is used to select the type of measurement (AC, DC, AC+DC) and the second functions marked in yellow next to the relevant positions of the switch.







It can also be used, in the configuration mode, to modify the default value (see § 4.4).

**Remark:** the key is invalid in the MAX/MIN/PEAK, HOLD and  $\Delta$ REL modes.

Successive presses on 		... serve
short	  	to select AC, DC or AC+DC. Depending on your choice, the screen displays AC, DC or AC+DC.
		to cycle through the $\Omega$ and diode test  modes and to return to the continuity test  .
		to reset the measurement process for the "indicator of order of the rotation of the phases" function.
long (> 2 sec)		to display the total three-phase power of a balanced system ( $\Sigma 3\Phi$ is displayed). by pressing again, to return to display of the single-phase power ( $\Sigma 3\Phi$ is off)

### 3.3. KEY

This key is used to backligh the display unit.

Successive presses on 		... serve
	    	to activate or de-activate the backlighting of the screen

**Remark:** the backlighting is switched off automatically at the end of 2 minutes.















### 3.4. KEY

#### 3.4.1. IN THE NORMAL MODE

This key activates detection of the MAX, MIN, PEAK+ and PEAK- values of the measurements made.









Max and Min are the extreme mean values in DC and the extreme RMS values in AC. Peak+ is the maximum instantaneous peak and Peak- the minimum instantaneous peak.

**Remark:** in this mode, the "automatic switching off" function of the device is automatically de-activated. The  symbol is displayed on the screen.

Successive presses on 		... serve
short	 	- to activate detection of the MAX/MIN/PEAK values, - to display the MAX, MIN, PEAK+ or PEAK- value successively, - to return to display of the present measurement without exiting from the mode (the values already detected are not erased). <b>Remark:</b> the MAX, MIN, PEAK+, PEAK- symbols are both displayed, but only the symbol of the quantity selected blinks. Example: If MIN has been selected, MIN blinks and MAX, PEAK+, PEAK- are lit steadily.
	  	- to activate detection of the MAX/MIN values, - to display the MAX or MIN value successively, - to return to display of the present measurement without exiting from the mode (the values already detected are not erased).
long (> 2 sec)	    	- to exit from the MAX/MIN/PEAK mode. The values previously recorded are then erased. <b>Remark:</b> if the HOLD function is activated, it is possible to exit from the MAX/MIN/PEAK mode. The HOLD function must first be de-activated.

**Remark:** "ΔREL" function can be used with the functions of the MAX/MIN/PEAK mode.





#### 3.4.2. THE MAX/MIN/PEAK MODE + ACTIVATION OF THE HOLD MODE

Successive presses on 		... serve
short	    	- to display successively the MAX/MEAN/PEAK values detected before the  key was pressed.

**Note:** the HOLD function does not interrupt the acquisition of new MAX, MIN, PEAK values.

#### 3.4.3. ACCESS TO THE TRUE-INTRUSH MODE ( SET TO )

This key allows measurement of the True-Inrush current (starting current, or over-current in steady-state operation) for AC or DC current only (not operational in AC+DC).







Successive presses on 		... serves
long (> 2 sec)		- <b>to enter</b> in the True-INTRUSH mode - "Inrh" is displayed for 3 s (the backlighting blinks). - the triggering threshold is displayed for 5 s (the backlighting is steady). - "-----" is displayed and the "A" symbol flashes. - after detection and acquisition, the inrush current measurement is displayed, after the calculations stage "-----" (backlighting off) <b>Remark:</b> the A symbol flashes to indicate "surveillance" of the signal. - <b>to exit</b> from the True-INTRUSH mode (return to simple current measurement).
short (< 2 sec) <b>Note:</b> a short press is functional only if an True-Inrush value has been detected.		- to display the PEAK+ value of the current, - to display the PEAK- value of the current, - to display the RMS True-Inrush current. <b>Remark:</b> the A symbol is displayed steadily this sequence.

### 3.5. KEY





This key is used to display the frequency measurements of a signal, of the power, and of the level of harmonics.

**Remark:** this button is not functional in DC.

#### 3.5.1. THE Hz FUNCTION IN THE NORMAL MODEL

Successive presses on 		... serves
short	 	- to display: - the frequency of the signal measured, - the present voltage (V) or current (A) measurement.
		- to display: - the apparent power (VA), - the reactive power (var), - the power factor (PF), - the frequency of the signal, - the active power (W).
long (> 2 sec)		- to enter or exit from the level of harmonics (THD) calculation and display mode.
then short		- to select THDf, THDr or the frequency of the fundamental.











#### 3.5.2. THE Hz FUNCTION + ACTIVATION OF THE HOLD MODE

Successive presses on 		... serves
short	 	- to store the frequency, - to display successively the stored frequency, then the voltage or the current, - to display in turn the stored values of THDf then of THDr, then of the frequency of the fundamental.  <b>Note:</b> the displayed values are those measured before pressing the HOLD key.

### 3.6. KEY

This key is used to display and store the reference value or to display the differential and relative value, in the unit of magnitude measured or in %.

**Remark:** in phasis rotation mode, the  key is not operating.

Successive presses on 		... serve
short	   	- to enter the ΔREL mode, to store then display the reference value. The ΔRef symbol is displayed.
		- to display the diferential value: (current value - reference (Δ)) The ΔREL symbol is displayed. - to display the relative value in % <u>current value - reference (Δ)</u> reference (Δ) The ΔREL and % symbols are displayed. - to display the reference. The ΔRef symbol is displayed, - to display the current value. The ΔRef symbol blinks.
long (> 2 sec)	   	- to exit from the ΔREL mode.

**Remark:** the "Relative mode ΔREL" function can be used with the functions of the MAX/MIN/PEAK mode.

## 4. USE

### 4.1. COMMISSIONING

Insert the batteries supplied with the device as follows:

1. Using a screwdriver, unscrew the screw of the battery compartment cover (item 1) on the back of the housing and open it ;
2. Place the 4 batteries in the compartment (item 2), taking care to get the polarities right ;
3. Close the battery compartment cover and screw it to the housing.

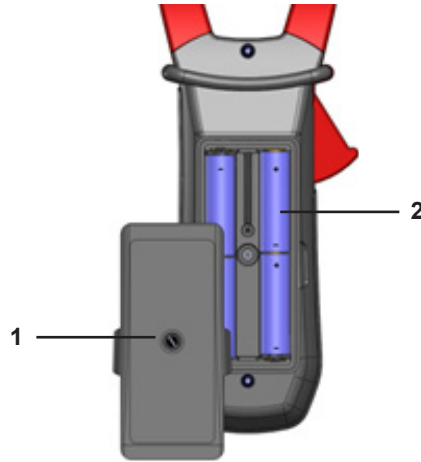

Figure 6: the battery compartment cover

### 4.2. STARTING UP THE CLAMP MULTIMETER

The switch is set to OFF. Turn the switch to the function of your choice. The whole display lights (all symbols) for a few seconds (see § 2.3), then the screen of the function chosen is displayed. The clamp multimeter is then ready to make measurements.

### 4.3. SWITCHING THE CLAMP MULTIMETER







The clamp multimeter can be switched off either manually, by setting the switch to OFF, or automatically, after ten minutes with no action on the switch and/or the keys. Thirty (30) seconds before the device is switched off, an audible signal sounds intermittently. To re-activate the device, press any key or turn the switch.

### 4.4. CONFIGURATION

As a safety measure, and to avoid repeated overloads on the inputs of the device, we recommend performing configuration operations only when the device is disconnected from all dangerous voltages.

#### 4.4.1. PROGRAMMING OF THE MAXIMUM RESISTANCE ALLOWED FOR A CONTINUITY

To program the maximum resistance allowed for a continuity:

1. From the OFF position, hold the  key down while turning the switch to , until the "full screen" display ends and a beep is emitted, to enter the configuration mode. The display unit indicates the value below which the buzzer is activated and the  symbol is displayed.  
The value stored by default is 40  $\Omega$ . The possible values lie between 1  $\Omega$  and 999  $\Omega$ .
2. To change the threshold, press the  key. The right-hand digit flashes: each press on the  key increments it. To shift to the next digit, apply a long press (> 2 s) to the  key.

To exit from the programming mode, turn the switch to another setting. The detection threshold chosen is stored (emission of a double beep).

#### 4.4.2. DE-ACTIVATION OF AUTOMATIC SWITCHING OFF (AUTO POWER OFF)

To de-activate automatic switching off:

1. In the OFF position, hold the **HOLD** key down while turning the switch to **V $\approx$** , until the "full screen" display ends and a beep is emitted, to enter the configuration mode. The **P** symbol is displayed.
2. When the **HOLD** key is released, the device is in the voltmeter function in the normal mode.
3. The return to Auto Power OFF takes place when the clamp is switched back on.

#### 4.4.3. PROGRAMMING OF THE CURRENT THRESHOLD FOR THE TRUE INRUSH MEASUREMENT

To program the triggering current threshold of the True INRUSH measurement:

1. In the OFF position, hold the **MAX/MIN PEAK** key down while turning the switch to **A $\approx$** , until the "full screen" display ends and a beep is emitted, to enter the configuration mode. The display unit indicates the percentage overshoot to apply to the measured current to determine the measurement triggering threshold.  
The value stored by default is 10 %, representing 110 % of the established current measured. The possible values are 5 %, 10 %, 20 %, 50 %, 70 %, 100 %, 150 %, and 200 %.
2. To change the threshold, press the **[Yellow]** key. The value flashes: each press on the **[Yellow]** key displays the next value. To record the chosen threshold, apply a long press (> 2 s) on the **[Yellow]** key. A confirmation beep is emitted.

To exit from the programming mode, turn the switch to another setting. The chosen threshold is stored (emission of a double beep).

**Note:** The starting current measurement triggering threshold is fixed at 1 % of the least sensitive range. This threshold is not adjustable.

#### 4.4.4. DEFAULT CONFIGURATION

To reset the clamp to its default parameters (factory configuration):

In the OFF position, hold the **[Yellow]** key down while turning the switch to **A $\approx$** , until the "full screen" display ends and a beep is emitted, to enter the configuration mode. The "rSt" symbol is displayed.

After 2 s, the clamp emits a double beep, then all of the symbols of the screen are displayed until the **[Yellow]** key is released. The default parameters are then restored:

- Continuity detection threshold = 40  $\Omega$
- True Inrush triggering threshold = 10 %

### 4.5. VOLTAGE MEASUREMENT (V)

To measure a voltage, proceed as follows:

1. Set the switch to **V $\approx$** .
2. Connect the black lead to the **COM** terminal and the red lead to "+",
3. Place the test probes or the crocodile clips on the terminals of the circuit to be measured. The device selects AC or DC automatically according to which measured value is larger. The AC or DC symbol lights in blinking mode.  
To select AC, DC or AC+DC manually, press the yellow key to reach the desired choice. The symbol corresponding to the choice made then lights in fixed mode.

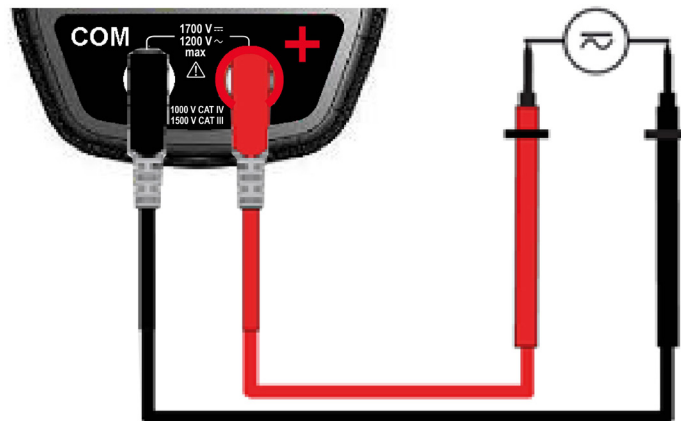

The measured value is displayed on the screen.

## 4.6. CONTINUITY TEST ●)))

**Warning:** Before performing the test, make sure that the circuit is off and any capacitors have been discharged.

1. Set the switch to , the ●))) symbol is displayed.
2. Connect the black lead to the "COM" terminal and the red lead to "+".
3. Place the test probes or the crocodile clips on the terminals of the circuit or component to be tested.

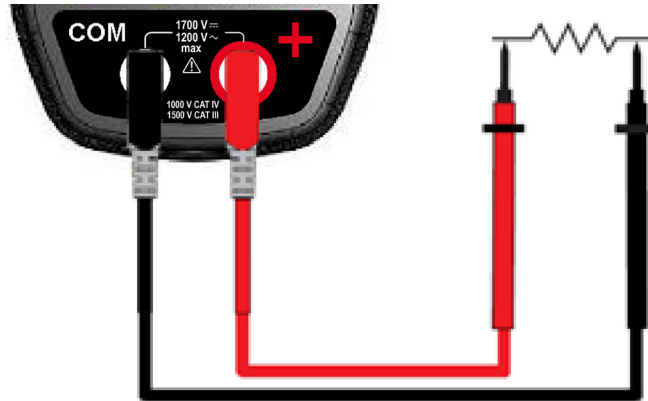

An audible signal is emitted if there is continuity, and the measured value is displayed on the screen.

### 4.6.1. AUTOMATIC COMPENSATION OF THE RESISTANCE OF THE LEADS

**Warning:** before the compensation is executed, the MAX/MIN/PEAK and HOLD modes must be de-activated.



To perform automatic compensation of the resistance of the leads, proceed as follows:

1. Short-circuit the leads connected to the device.
2. Hold the **HOLD** key down until the display unit indicates the lowest value. The device measures the resistance of the leads.
3. Release the **HOLD** key. The correction and the  $\rightarrow 0 \leftarrow$  symbol are displayed. The value displayed is stored.

**Remark:** The correction value is stored only if it is  $\leq 2 \Omega$ . Above  $2 \Omega$ , the value displayed blinks and is not stored.

## 4.7. RESISTANCE MEASUREMENT $\Omega$

**Warning:** Before making a resistance measurement, make sure that the circuit is cold and any capacitors have been discharged.

1. Set the switch to  and press the  key.  
The  $\Omega$  symbol is displayed.
2. Connect the black lead to the "COM" terminal and the red lead to "+".
3. Place the test probes or the crocodile clips on the terminals of the circuit or component to be measured.

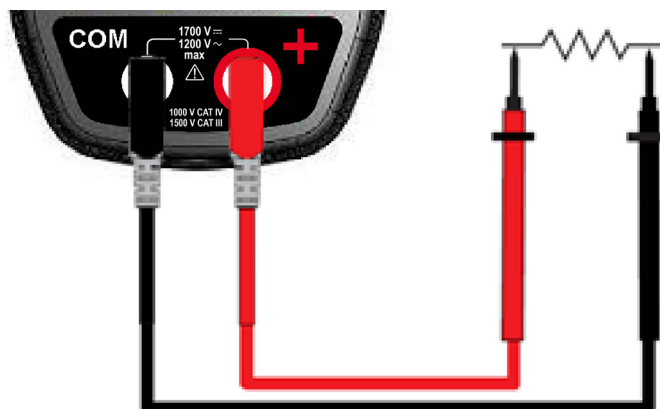



The measured value is displayed on the screen.

**Remark:** to measure low resistance values, first carry out the compensation of the resistance of the leads (see § [4.6.1](#))

## 4.8. DIODE TEST $\rightarrow|+$

**Warning:** Before performing the diode test, make sure that the circuit is cold and any capacitors have been discharged.

1. Set the switch to  and press the  key twice. The  $\rightarrow|+$  symbol is displayed.
2. Press the  key twice. The " $\rightarrow|+$ " symbol is displayed.
3. Connect the black lead to the "COM" terminal and the red lead to "+".
4. Place the test probes or the crocodile clips on the terminals of the component to be tested.

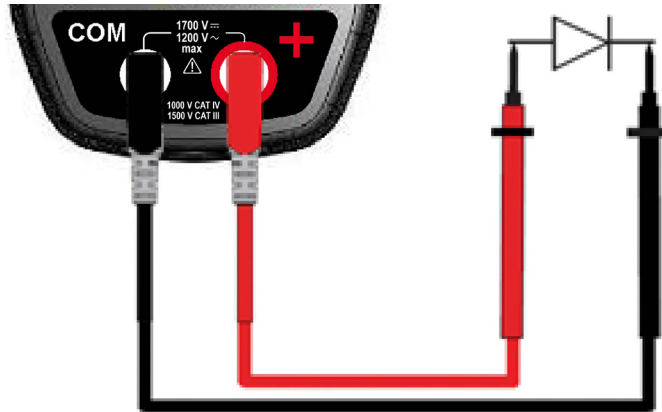

The measured value is displayed on the screen.

## 4.9. CURRENT MEASUREMENT (A)



The jaws are opened by pressing the trigger on the body of the device. The arrow on the jaws of the clamp (see the diagram below) must point in the presumed direction of flow of the current, from the generator to the load. Make sure that the jaws have closed correctly.

**Remark:** the measurement results are optimal when the conductor is centered in the jaws (aligned with the centering marks).

The device automatically selects AC or DC according to which measured value is larger. The AC or DC symbol blinks.

### 4.9.1. AC MEASUREMENT

For an AC current measurement, proceed as follows:

1. Set the switch to  and select AC by pressing the  key. The AC symbol is displayed.
2. Encircle only the conductor concerned with the clamp.

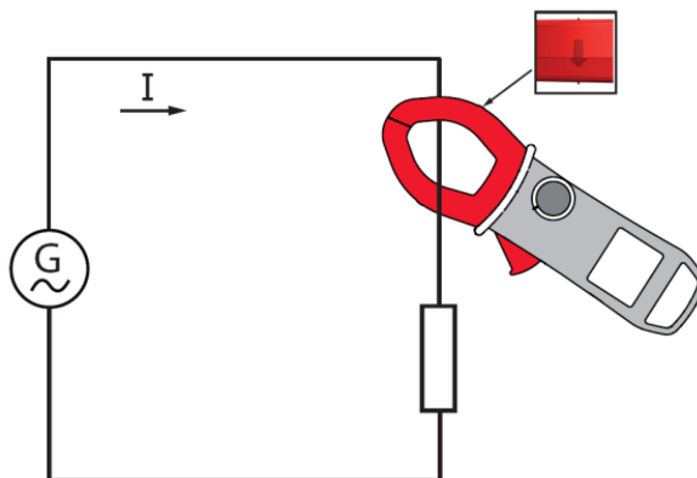

The measured value is displayed on the screen.

#### 4.9.2. DC OR AC+DC MEASUREMENT

To measure the DC or AC+DC current, if the display unit does not indicate "0", first correct the DC zero as follows:

##### Step 1: to correct the DC zero

**Important:** The clamp must not be closed on the conductor during the DC zero correction. Hold the clamp in the same position during the whole procedure so that the correction value will be exact.

Press the **HOLD** key until the device emits a double beep and displays a value near "0". The correction value is stored until the clamp is powered down.

**Remark:** the correction is effected only if the value displayed is  $< \pm 20$  A, otherwise the value displayed blinks and is not stored. The clamp must be re-calibrated.

##### Step 2: to make a measurement

1. The switch is set to **A**. Select DC or AC+DC by pressing the yellow key until the desired choice is reached.
2. Apply the clamp to only the conductor concerned.

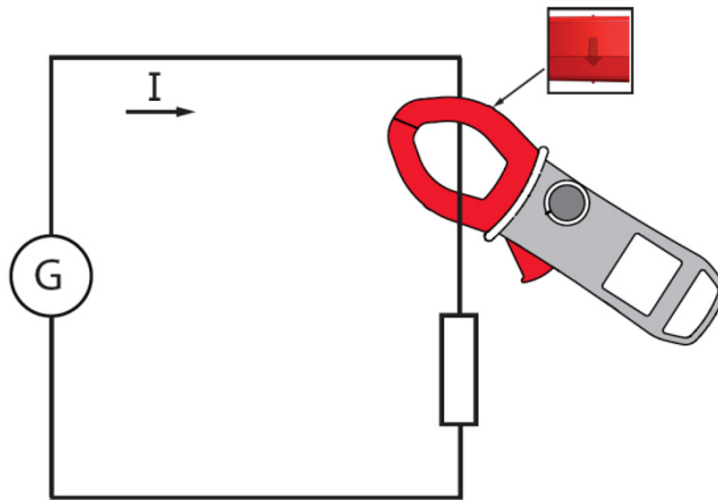

The measurement is displayed on screen.

#### 4.10. STARTING CURRENT OR OVER-CURRENT (TRUE INRUSH) MEASUREMENT

**Remark:** the measurement can be made only in AC or DC (AC+DC mode disabled).

To measure a starting current or over current, proceed as follows:

1. Set the switch to **A**, correct the DC zero (§ 4.9.2), then apply the clamp around the single conductor concerned.
2. Effect a long press on the **MAX/MIN PEAK** key. The InRh symbol is displayed, then the triggering threshold. The clamp then awaits detection of the True-Inrush current. "-----" is displayed and the "A" symbol flashes.
3. After detection and acquisition for 100 ms, the RMS value of the True-Inrush current is displayed, along with the PEAK+/PEAK- values subsequently.
4. A long press on the **MAX/MIN PEAK** key or a change of function leads to exiting from the True-Inrush mode.

**Remark:** the triggering threshold in A is 20 A if the initial current is zero (starting of installation), it is that set in the configuration (see § 4.4.3) for an established current (overload in a installation).



### 4.11. POWER MEASUREMENTS W, VA, var AND PF

This measurement is possible in single-phase or in balanced three-phase.

**Reminder:** in DC or AC+DC power measurement, first correct the DC zero in current (see § 4.9.2, step 1).

For the power factor (PF) and the powers VA and var, the measurement is possible only in AC or AC+DC.



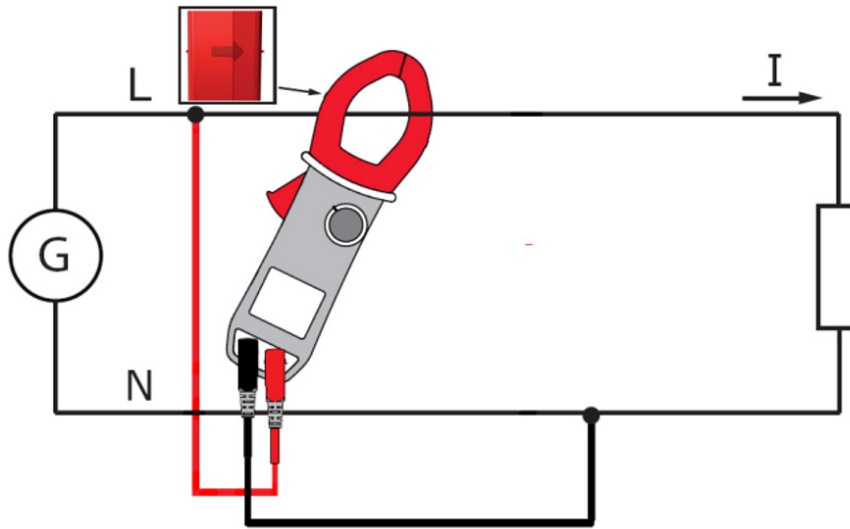

#### 4.11.1. MEASUREMENT OF SINGLE-PHASE POWER

1. Set the switch to  and select VA, var or PF by pressing the  key until the desired choice is reached.
2. The device automatically displays AC+DC. To select AC, DC or AC+DC, press the  key until the desired choice is reached.
3. Connect the black lead to the "COM" terminal and the red lead to "+".
4. Place the test probes or the crocodile clips of the black lead on the neutral (N), then those of the red lead on the L phase.
5. Clamp only the corresponding conductor, respecting the direction.



The measurement is displayed on screen.

#### 4.11.2. BALANCED THREE-PHASE POWER MEASUREMENT

1. Set the switch to  and select VA, var or PF by pressing the  key until the desired choice is reached.
2. Press the yellow  key until the  $\Sigma 3\Phi$  symbol is displayed.
3. The device automatically displays AC+DC. To select AC, DC or AC+DC, press the yellow  key until the desired choice is reached.
4. Connect the black lead to the "COM" terminal and the red lead to "+".
5. Connect the leads and the clamp to the circuit as follows:

If the red lead is connected ...	... and the black lead is connected	... then the clamp is on the conductor
To the L1 phase	to the L2 phase	of the L3 phase
To the L2 phase	to the L3 phase	of the L1 phase
To the L3 phase	to the L1 phase	of the L2 phase

**Reminder:** the arrow on the jaws of the clamp (see the diagram below) must point in the presumed direction of flow of the current from the source (producer) to the load (consumer).



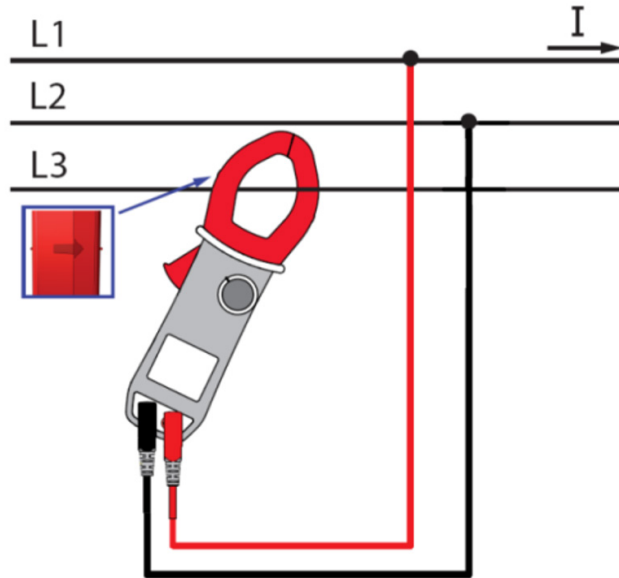

The measurement is displayed on screen.

**Remark:** You can also measure the three-phase power on a balanced 4-wire network by proceeding in the same way, or by proceeding as for the measurement on a single-phase network, then multiplying the value found by three.

## 4.12. "DIRECTION OF ROTATION OF THE PHASES" OR "ORDER OF THE PHASES" MODE

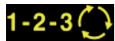

This mode is used to determine the order of the phases of a three-phase network by the "2-wire" method.

To determine the order of the phases, proceed as follows:

### Step 1: determination of a "reference" period:

1. Set the switch to . The **rdy** symbol is displayed; the device is ready for the first phase order determination measurement.
2. Connect the black lead with crocodile clip to the "**COM**" terminal and the red lead with test probe to "**+**".
3. Connect the crocodile clip to the presumed L1 phase and apply the red test probe to the presumed L2 phase.
4. Press the yellow key. The **ref** symbol blinks on the screen. The instrument is ready to determine the reference period.

When the reference period has been determined, an audible signal sounds and the **ref** and symbols are displayed.

**Remark:** if the reference period has not been determined, the device emits a beep and displays the "Err Hz" or "Err V" message.

The symbol flashes, then the "**rdy**" message is displayed on the screen. Repeat the procedure from 4.

### Step 2: determination of a "measurement" period

1. Within the next 10 seconds, apply the test probe to the presumed L3 phase. The "MEAS" indication then blinks on the display unit as soon as the L2 phase is disconnected, the device is in the calculation phase.

**Remark:** if the measurement period has not been determined, the device emits a beep and displays the "Err Hz" or "Err V" message, then "rdy". Repeat the procedure from 4.

**Result:** when the order of the phases has been determined, the device emits a beep and the indication of order of the phases is displayed on the screen, as follows:

- 0.1.2.3 when the direction of rotation is direct. The "0" symbol blinks and turns clockwise,
- 0.3.2.1 when the direction of rotation is reversed: The "0" symbol blinks and turns anticlockwise.

**Remark:** if the order of the phases has not been determined, the device emits a beep and displays the "Err" message. Repeat the procedure from 4.

## 4.13. FREQUENCY MEASUREMENT (Hz)

The frequency measurement is available in V, W and A for AC and AC+DC quantities. The measurement is based on a count of the passages of the signal through zero (positive-going edges).

### 4.13.1. FREQUENCY MEASUREMENT IN VOLTAGE

To measure the frequency in voltage, proceed as follows:

1. Set the switch to **V $\approx$**  and press the **Hz** key. The Hz symbol is displayed.
2. Select AC or AC+DC by pressing the yellow key until the desired choice is reached.
3. Connect the black lead to the "COM" terminal and the red lead to "+".
4. Place the test probes or the crocodile clips on the terminals of the circuit to be measured.

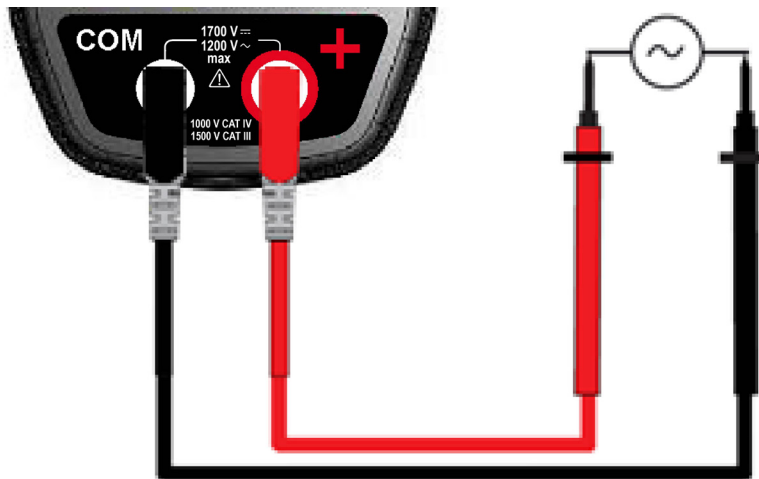

The measured value is displayed on the screen.

### 4.13.2. FREQUENCY MEASUREMENT IN CURRENT

1. Set the switch to **A $\approx$**  and press the **Hz** key. The "Hz" symbol is displayed.
2. Select AC or AC+DC by pressing the yellow key until the desired choice is reached.
3. Encircle only the conductor concerned with the clamp.

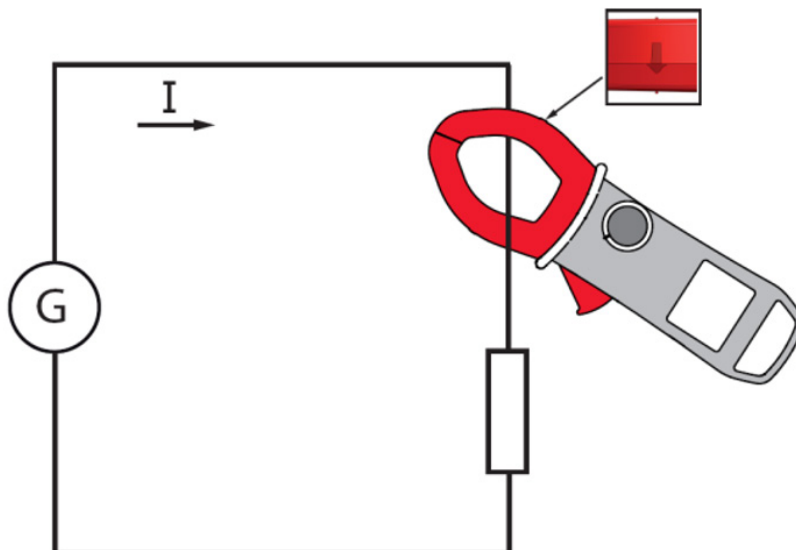

The measured value is displayed on the screen.

### 4.13.3. MEASUREMENT OF FREQUENCY IN POWER

In the single-phase AC or AC+DC Power (W) setting, it is possible to display the frequency of the voltage of the signal on the terminals.

In the balanced three-phase AC or AC+DC Power (W) setting, it is possible to display the frequency of the phase-to-phase voltage of the signal on the terminals.

## 4.14. MEASUREMENT OF THE LEVEL OF HARMONICS (THD) AND OF THE FREQUENCY OF THE FUNDAMENTAL (NETWORK)

The device measures the total harmonic distortion with respect to the fundamental (THDf) and the total harmonic distortion with respect to the true RMS value of the signal (THDr) in voltage and in current. Similarly, it determines the frequency of the fundamental by digital filtering and FFT, for network frequencies of 50, 60, 400, and 800 Hz.

### 4.14.1. MEASUREMENT OF THE THD AND OF THE FREQUENCY OF THE FUNDAMENTAL IN VOLTAGE

1. Set the switch to **V** and press and hold (> 2 s) the **Hz** key. The "THDf" symbol is displayed. To select THDr, press the **Hz** key again. The "THDr" symbol is displayed. To select the frequency of the fundamental, press the **Hz** key again. The "Hz" symbol is displayed.

2. Connect the black lead to the "COM" terminal and the red lead to "+".

3. Place the test probes or the crocodile clips on the terminals of the circuit to be measured.

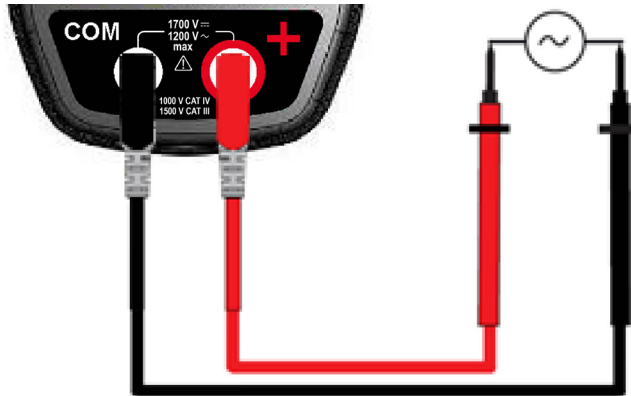

The measurement is displayed on screen.

### 4.14.2. MEASUREMENT OF THE THD AND OF THE FREQUENCY OF THE FUNDAMENTAL IN CURRENT

1. Set the switch to **A** and press and hold (> 2 s) the **Hz** key. The THDf symbol is displayed. To select THDr, press **Hz** again. The THDr symbol is displayed. To select the frequency of the fundamental, press the **Hz** key again. The Hz symbol is displayed.

2. Apply the clamp to only the conductor concerned.

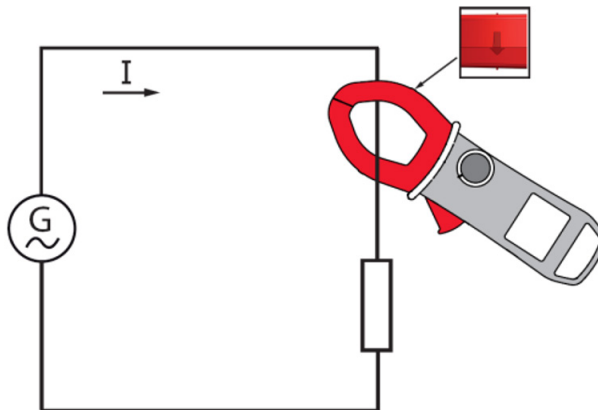

The measurement is displayed on screen.

## 5. CHARACTERISTICS

### 5.1. REFERENCE CONDITIONS

Quantities of influence	Reference conditions
Temperature	23°C ± 2°C
Relative humidity	45 % to 75 %
Supply voltage	6.0 V ± 0.5 V
Frequency range of the applied signal	45 - 65 Hz
Sine wave	pure
Peak factor of the applied alternating signal	$\sqrt{2}$
Position of the conductor in the clamp	centred
Adjacent conductors	none
Alternating magnetic field	none
Electric field	none

### 5.2. CHARACTERISTICS UNDER THE REFERENCE CONDITIONS

The uncertainties are expressed in ± (x % of the reading (R) + y points (pt)).

#### 5.2.1. DC VOLTAGE MEASUREMENT

Measurement range	0.00 V to 99.99 V	100.0 V to 999.9 V	1 000 V to 1 700 V (1)
Specified measurement range	0 to 1 600 V		
Uncertainties	from 0.00 V to 9.99 V ± (1 % R + 10 pts) from 10.00 V to 99.99 V ± (1 % R + 3 pts)	± (1 % R + 4 pts)	
Resolution	0.01 V	0.1 V	1 V
Input impedance	10 MΩ		

**Note (1):** The display indicates "+OL" above + 3 400 V and "-OL" below - 3 400 V, in REL mode.

Above 1 700 V, a repetitive beep indicates that the voltage being measured is greater than the safety voltage for which the device is guaranteed.

#### 5.2.2. AC VOLTAGE MEASUREMENT

Measurement range	0.15 V to 99.99 V	100.0 V to 999.9 V	1 000 V to 1 200 V RMS 1 700 V peak (1)
Specified measurement range (2)	0 to 1 100 VAC / 1 600 V peak		
Uncertainties	from 0.15 V to 9.99 V ± (1 % R + 10 pts) from 10.00 V to 99.99 V ± (1 % R + 3 pts)	± (1 % R + 4 pts)	
Resolution	0.01 V	0.1 V	1 V
Input impedance	10 MΩ		

**Note (1):** The display indicates "OL" above 1 700 V (in PEAK mode).

Above 1 200 V RMS, a repetitive beep indicates that the voltage being measured is greater than the safety voltage for which the device is guaranteed.

Bandwidth in AC = 3 kHz.

**Note (2):** Any value between zero and the min. threshold of the measurement range (0.15 V) is forced to "-----" on the display.

### 5.2.3. AC+DC VOLTAGE MEASUREMENT

<b>Measurement range (2)</b>	0.15 V to 99.99 V	100.0 V to 999.9 V	1000 V to 1 200 V RMS (1) 1 700 V peak
<b>Specified measurement range</b>	0 to 1 100 VAC / 1 600 V peak		
<b>Uncertainties</b>	from 0.15 V to 9.99 V $\pm$ (1 % R + 10 pts) from 10.00 V to 99.99 V $\pm$ (1 % R + 3 pts)	$\pm$ (1 % R + 4 pts)	
<b>Resolution</b>	0.01 V	0.1 V	1 V
<b>Input impedance</b>	10 M $\Omega$		

**Note (1):** The display indicates "OL" above 1 700 V (in PEAK mode).

Above 1 200 V (DC or RMS), a repetitive beep indicates that the voltage being measured is greater than the safety voltage for which the device is guaranteed.

Bandwidth in AC = 3 kHz.

**Note (2):** Any value between zero and the min. threshold of the measurement range (0.15 V) is forced to "-----" on the display.

**Specified characteristics in MAX/MIN mode in voltage** (from 10 Hz to 1 kHz in AC and AC+DC, and from 0.30 V):

- Uncertainties: add 1 % R to the values in the tables above.
- Capture time of the extrema: approximately 100 ms.

**Specified characteristics in PEAK mode in voltage** (from 10 Hz to 1 kHz in AC and AC+DC):

- Uncertainties: add 1.5 % R to the values in the tables above.
- PEAK capture time: 1 ms min to 1.5 ms max.

### 5.2.4. DC CURRENT MEASUREMENT

<b>Measurement range (2)</b>	0.00 A to 99.99 A	100.0 A to 999.9 A	1 000 A to 1 500 A (1)
<b>Specified measurement range</b>	0 to 100 % of the measurement range		
<b>Uncertainties (2) (zero corrected)</b>	$\pm$ (1 % R + 10 pts)	$\pm$ (1 % R + 3 pts)	$\pm$ (1.5 % R + 3 pts)
<b>Resolution</b>	0.01 A	0.1 A	1 A

**Note (1):** The display indicates "+OL" above 3 000 A and "-OL" below - 3 000 A in REL mode. The "-" and "+" signs are managed (polarity).

**Note (2):** The residual current at zero depends on the remanence, it can be corrected by the "DC zero" function of the HOLD key.

### 5.2.5. AC CURRENT MEASUREMENT

<b>Measurement range (2)</b>	0.25 A to 99.99 A	100.0 A to 999.9 A	1 000 A (1 500 A peak) (1)
<b>Specified measurement range</b>	0 to 100 % of the measurement range		
<b>Uncertainties</b>	$\pm$ (1 % R + 10 pts)	$\pm$ (1 % R + 3 pts)	
<b>Resolution</b>	0.01 A	0.1 A	1 A

**Note (1):** The display indicates "OL" above 1 500 A, in PEAK mode. The "-" and "+" signs are not managed.

Bandwidth in AC = 1 kHz.

**Note (2):** Any value between zero and the min. threshold of the measurement range (0.25 A) is forced to "-----" on the display.

### 5.2.6. AC+DC INTENSITY MEASUREMENT

<b>Measurement range (2)</b>	0.25 A to 99.99 A	100.0 A to 999.9 A	AC: 1 000 A (1 500 A peak) DC or PEAK: 1 000 A to 1 500 A (1)
<b>Specified measurement range</b>	0 to 100 % of the measurement range		
<b>Uncertainties (2) (zero corrected)</b>	± (1 % R + 10 pts)	± (1 % R + 3 pts)	± (1.5 % R + 3 pts)
<b>Resolution</b>	0.01 A	0.1 A	1 A

**Note (1):** In DC, the display indicates "+OL" above + 3 000 A and "-OL" above - 3 000 A in REL mode. The "-" and "+" signs are managed (polarity).

: In AC and AC+DC, the display indicates "OL" above 1 500 A, in PEAK mode. The "-" and "+" signs are not managed.  
Bandwidth in AC = 1 kHz.

**Note (2):** In AC, any value between zero and the min. threshold of the measurement range (0.25 A) is forced to "-----" on the display.

**Specific characteristics in MAX/MIN mode in current** (from 10 Hz to 1 kHz, in AC and AC+DC, and from 0,30 A):

- Uncertainties (zero corrected): add 1 % R to the values in the tables above.
- Capture time of the extrema: approximately 100 ms.

**Specific characteristics in PEAK mode in current** (from 10 Hz to 1 kHz in AC and AC+DC):

- Uncertainties: add ± (1.5 % R + 0.5 A) to the values in the tables above.
- PEAK capture time: 1 ms min. to 1.5 ms max.

### 5.2.7. TRUE-INRUSH MEASUREMENT

<b>Measurement range</b>	10 A to 1 000 AAC	10 A to 1 500 ADC
<b>Specified measurement range</b>	0 to 100 % of the measurement range	
<b>Uncertainties</b>	± (5 % R + 5 pts)	
<b>Resolution</b>	1 A	

**Specific characteristics in PEAK mode in True-Inrush** (from 10 Hz to 1 kHz in AC):

- Uncertainties: add ± (1.5 % R + 0.5 A) to the values in the tables above.
- PEAK capture time: 1 ms min. to 1.5 ms max.

### 5.2.8. CONTINUITY MEASUREMENT

<b>Measurement range</b>	0.0 Ω to 999.9 Ω
<b>Open-circuit voltage</b>	≤ 3.6 V
<b>Measurement current</b>	550 μA
<b>Uncertainties</b>	± (1 % R + 5 pts)
<b>Buzzer triggering threshold</b>	Adjustable from 1 Ω to 999 Ω (40 Ω is the default)

### 5.2.9. RESISTANCE MEASUREMENT

<b>Measurement range (1)</b>	0.0 Ω to 99.9 Ω	100.0 Ω to 999.9 Ω	1 000 Ω to 9999 Ω	10.00 kΩ to 99.99 kΩ
<b>Specified measurement range</b>	1 to 100 % of the measurement range		0 to 100 % of the measurement range	
<b>Uncertainties</b>	± (1% R + 10 pts)	± (1 % R + 5 pts)		
<b>Resolution</b>	0.1 Ω		1 Ω	10 Ω
<b>Open-circuit voltage</b>	≤ 3.6 V			
<b>Measurement current</b>	550 μA		100 μA	10 μA

**Note (1):** Above the maximum display value, the display unit indicates "OL".  
The "-" and "+" signs are not managed.

**Specific characteristics in MAX-MIN mode:**

- Uncertainties: add 1 % R to the values of the table above.
- Capture time of the extrema: approximately 100 ms.

**5.2.10. DIODE TEST**

<b>Measurement range</b>	0.000 V to 3.199 VDC
<b>Specified measurement range</b>	1 to 100 % of the measurement range
<b>Uncertainties</b>	$\pm (1 \% R + 10 \text{ pts})$
<b>Resolution</b>	0.001 V
<b>Measurement current</b>	0.55 mA
<b>Indication: junction reversed or open-circuit</b>	Display of "OL" when the measured voltage > 3,199 V

**Note:** The "-" sign is disabled for the diode test function.

**5.2.11. ACTIVE DC POWER MEASUREMENTS**

<b>Measurement range (2)</b>	0 W to 9 999 W	10.00 kW to 99.99 kW	100.0 kW to 999.9 kW	1 000 kW to 2 550 kW (1)
<b>Specified measurement range</b>	1 to 100 % of the measurement range	0 to 2 400 kW		
<b>Uncertainties (3)</b>	until 1 000 A $\pm (2 \% R + 10 \text{ pts})$ from 1 000 A to 1 500 A $\pm (2.5 \% R + 10 \text{ pts})$	until 1 000 A $\pm (2 \% R + 5 \text{ pts})$ from 1 000 A to 1 500 A $\pm (2.5 \% R + 5 \text{ pts})$		
<b>Resolution</b>	1 W	10 W	100 W	1 000 W

**Note (1):** Display of O.L or  $\pm$  O.L above  $\pm 5 100$  kW, in REL mode.

**Note (2):** Any applied voltage greater than 1 700 V causes the emission of an intermittent alarm beep to report a dangerous overload.

**Note (3):** The measurement result may be perturbed by an instability linked to the current measurement (approximately 0.1 A).  
Example: for a power measurement made at 10 A, the instability of the measurement will be 0.1 A / 10 A or 1 %.

**5.2.12. ACTIVE AC POWER MEASUREMENTS**

<b>Measurement range (2) (4)</b>	5 W to 9 999 W	10.00 kW to 99.99 kW	100.0 kW to 999.9 kW	1 000 kW to 1 200 kW (1)
<b>Specified measurement range</b>	1 to 100 % of the measurement range	0 to 1 100 kW		
<b>Uncertainties (3) (7)</b>	$\pm (2 \% R + 10 \text{ pts})$	$\pm (2 \% R + 4 \text{ pts})$		
<b>Resolution</b>	1 W	10 W	100 W	1 000 W

**Note (1):** The bandwidth is 3 kHz in voltage and 1 kHz in current in AC.

**Notes (2) and (3):** of the previous § apply.

**Note (4):** Any power measured less than 5 W causes the display of dashes "-----".

**Note (5):** The active powers are positive for power consumed and negative for power generated.

**Note (6):** The signs of the active and reactive powers and power factor are defined by the four-quadrant rule below:  
 The diagram below sums up the signs of the power as a function of the phase angle between U and I:

- Quadrant 1: Active power P sign + (power consumed)
- Quadrant 2: Active power P sign - (power generated)
- Quadrant 3: Active power P sign - (power generated)
- Quadrant 4: Active power P sign + (power consumed)

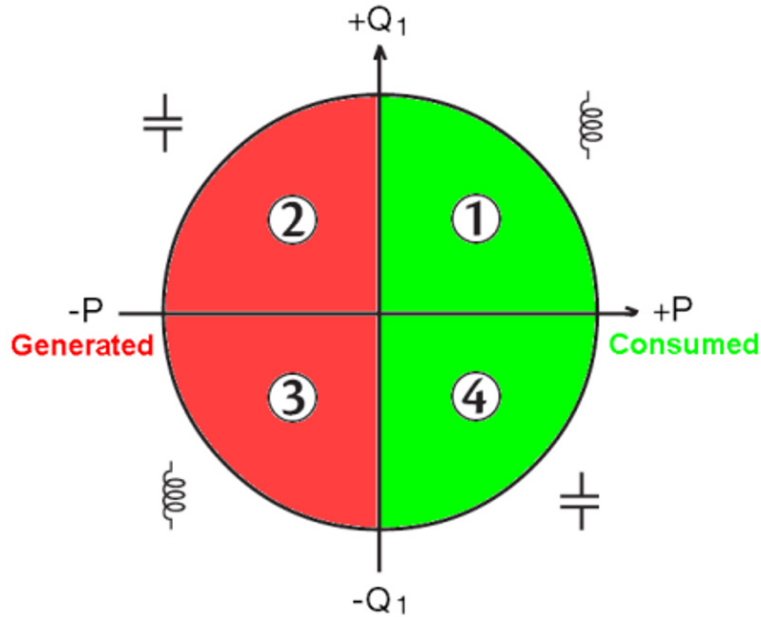

**Note (7):** In balanced three-phases, with deformed signals (THD and harmonics), uncertainties are guaranteed since  $\Phi > 30^\circ$ . Additional errors are following, depending of THD:

- Add + 1 % for 10 % < THD < 20 %
- Add + 3 % for 20 % < THD < 30 %
- Add + 5 % for 30 % < THD < 40 %

**5.2.13. ACTIVE AC+DC POWER MEASUREMENTS**

<b>Measurement range (2) (4)</b>	5 W to 9 999 W	10.00 kW to 99.99 kW	100.0 kW to 999.9 kW	1 000 kW to 2 550 kW (1)
<b>Specified measurement range</b>	1 to 100 % of the measurement range	0 to 2 400 kW		
<b>Uncertainties (3) (7)</b>	until 1 000 A ± (2 % R + 10 pts) from 1 000 A to 1 500 A ± (2.5 % R + 10 pts)	until 1 000 A ± (2 % R + 4 pts) from 1 000 A to 2 000 A ± (2.5 % R + 4 pts)		
<b>Resolution</b>	1 W	10 W	100 W	1 000 W

**Note (1):** The bandwidth is 3 kHz in voltage and 1 kHz in current in AC.

**Notes (2), (3), (4), 5, 6 and (7):** of the previous § apply.



**5.2.14. MEASUREMENT OF APPARENT AC POWER**

<b>Measurement range (2) (4)</b>	5 VA to 9 999 VA	10.00 kVA to 99.99 kVA	100.0 kVA to 999.9 kVA	1 000 kVA to 1 200 kVA (1)
<b>Specified measurement range</b>	1 to 100 % of the measurement range	0 to 1 100 kVA		
<b>Uncertainties (3)</b>	± (2 % R + 10 pts)		± (2 % R + 4 pts)	
<b>Resolution</b>	1 VA	10 VA	100 VA	1 000 VA

**Note (1):** The bandwidth is 3 kHz in voltage and 1 kHz in current in AC.

**Notes (2), (3) and (4):** of the previous § apply.

**5.2.15. MEASUREMENT OF APPARENT AC+DC POWER**

<b>Measurement range (2) (4)</b>	5 VA to 9 999 VA	10.00 kVA à 99.99 kVA	100.0 kVA à 999.9 kVA	1 000 kVA à 2 550 kVA (1)
<b>Specified measurement range</b>	1 to 100 % of the measurement range	0 to 100 % of the measurement range		
<b>Uncertainties (3)</b>	until 1 000 A ± (2 % R + 10 pts) from 1 000 A to 1 500 A ± (2.5 % R + 10 pts)	until 1 000 A ± (2 % R + 4 pts) from 1 000 A to 1 500 A ± (2.5 % R + 4 pts)		
<b>Resolution</b>	1 VA	10 VA	100 VA	1 000 VA

**Note (1):** Display of O.L above 2 550 kVA in single-phase (1 700 V x 1 500 A).  
The bandwidth is 3 kHz in voltage and 1 kHz in current in AC.

**Notes (2), (3) and (4):** of the previous § apply.

**5.2.16. MEASUREMENT OF REACTIVE AC POWER**

Total reactive power  $Q = \sqrt{(S^2 - P^2)}$   
where S = apparent power  
and P = active power

<b>Measurement range (2) (4)</b>	5 var to 9 999 var	10.00 kvar to 99.99 kvar	100.0 kvar to 999.9 kvar	1 000 kvar to 1 200 kvar (1)
<b>Specified measurement range</b>	1 to 100 % of the measurement range	0 to 1 100 kvar		
<b>Uncertainties (3) (8)</b>	± (2 % R + 10 pts)		± (2 % L + 4 pts)	
<b>Resolution</b>	1 var	10 var	100 var	1 kvar

**Note (1):** The bandwidth is 3 kHz in voltage and 1 kHz in current in AC.

**Notes (2), (3) and (4):** of the previous § apply.

**Note (5):** In single-phase, the sign of the reactive power is determined by the phase lead or lag between the U and I signs, while in balanced three-phase, it is determined by the calculation on the samples.

**Note (6):** Signs of reactive powers according to the four-quadrant rule (§ 5.2.12):

- Quadrant 1: Reactive power Q      sign +
- Quadrant 2: Reactive power Q      sign +
- Quadrant 3: Reactive power Q      sign -
- Quadrant 4: Reactive power Q      sign -

**Note (8):** In single phase, with deformed signals (THD and harmonics), uncertainties are guaranteed since  $\Phi > 30^\circ$ . Additional errors are following, depending of THD:

- Add + 1 % for 10 % < THD < 20 %
- Add + 3 % for 20 % < THD < 30 %
- Add + 5 % for 30 % < THD < 40 %

**5.2.17. MEASUREMENT OF REACTIVE AC+DC POWER**

Total reactive power  $Q = \sqrt{(S^2 - P^2)}$   
 where S = apparent power  
 and P = active power

<b>Measurement range (2) (4)</b>	5 var to 9 999 var	10.00 kvar to 99.99 kvar	100.0 kvar to 999.9 kvar	1 000 kvar to 2 550 kvar (1)
<b>Specified measurement range</b>	1 to 100 % of the measurement range	0 to 2 400 kvar		
<b>Uncertainties (3) (8)</b>	until 1 000 A ± (2 % R + 10 pts) from 1 000 A to 1 500 A ± (2.5 % R + 10 pts)	until 1 000 A ± (2 % R + 4 pts) from 1 000 A to 1 500 A ± (2.5 % R + 4 pts)		
<b>Resolution</b>	1 var	10 var	100 var	1 kvar

**Note (1):** Display of O.L. above 2 550 kvar in single-phase (1 700 V x 1 500 A).  
 The bandwidth is 3 kHz in voltage and 1 kHz in current in AC.

**Notes (2), (3), (4), 5, 6, and (8):** of the previous § apply.

**Specific characteristics in MAX/MIN mode in power** (from 10 Hz to 1 kHz):

- Uncertainties: add 1 % R to the values in the tables above.
- Capture time: approximately 100 ms.

**5.2.18. CALCULATION OF THE POWER FACTOR**

<b>Measurement range (1)</b>	- 1.00 to + 1.00
<b>Specified measurement range</b>	70 to 100 % of the measurement range
<b>Uncertainties (7)</b>	± (2 % R + 3 pts)
<b>Resolution</b>	0.01

**Note (1):** If one of the terms in the calculation of the power factor is displayed as "O.L.", or forced to zero, the display of the power factor is an indeterminate value "-----".

**Note (7):** of the previous § apply.

**Note (9):** Sign of the power factor according to the four-quadrant rule (§ 5.2.12):

Quadrant 1:	Power factor PF	sign + (inductive system)
	Cos Φ	sign +
Quadrant 2:	Power factor PF	sign - (capacitive system)
	Cos Φ	sign -
Quadrant 3:	Power factor PF	sign + (inductive system)
	Cos Φ	sign -
Quadrant 4:	Power factor PF	sign - (capacitive system)
	Cos Φ	sign +

**Specific characteristics in MAX/MIN mode** (from 10 Hz to 1 kHz):

- Uncertainties: add 1 % R to the values in the tables above.
- Capture time: approximately 100 ms.

**5.2.19. FREQUENCY MEASUREMENT**

**Characteristics in voltage**

<b>Measurement range (1)</b>	5.0 Hz to 999.9 Hz	1 000 Hz to 9 999 Hz	10.00 kHz to 19.99 kHz
<b>Specified measurement range</b>	1 to 100 % of the measurement range		0 to 100 % of the measurement range
<b>Uncertainties</b>	± (0.4 % R + 1 pt)		
<b>Resolution</b>	0.1 Hz	1 Hz	10 Hz

**Characteristics in current**

<b>Measurement range (1)</b>	5.0 Hz to 999.9 Hz
<b>Specified measurement range</b>	1 to 100 % of the measurement range
<b>Uncertainties</b>	± (0.4 % R + 1 pt)
<b>Resolution</b>	0.1 Hz

**Note (1):** If the level of the signal is too low ( $U < 3\text{ V}$  or  $I < 3\text{ A}$ ) or if the frequency is less than 5 Hz, the device cannot determine the frequency and displays dashes "-----".

**Specific characteristics in MAX/MIN mode** (from 10 Hz to 1 kHz in voltage and from 10 Hz to 1 kHz in current):

- Uncertainties: add 1 % R to the values of the table above.
- Capture time of the extrema: approximately 100ms.

**5.2.20. CHARACTERISTICS IN THDr**

<b>Measurement range</b>	0.0 - 100 %
<b>Specified measurement range</b>	0 to 100 % of the measurement range
<b>Uncertainties</b>	± (5 % R ± 2 pts) in voltage ± (5 % R ± 5 pts) in current
<b>Resolution</b>	0.1 %

**5.2.21. CHARACTERISTICS IN THDf**

<b>Measurement range</b>	0.0 - 1 000 %
<b>Specified measurement range</b>	0 to 100 % of the measurement range
<b>Uncertainties</b>	± (5 % R ± 2 pts) in voltage ± (5 % R ± 5 pts) in current
<b>Resolution</b>	0.1 %

**Note:** The display is "-----" if the input signal is too low ( $U < 8\text{ V}$  or  $I < 9\text{ A}$ ) or if the frequency is less than 5 Hz.

**Specific characteristics in MAX/MIN mode in THD** (from 10 Hz to 1 kHz):

- Uncertainties: add 1 % R to the values in the tables above.
- Capture time of the extrema: approximately 100 ms.

**5.2.22. INDICATION OF ORDER OF THE PHASES**

<b>Frequency range</b>	47 Hz to 400 Hz
<b>Acceptable voltage range</b>	50 V to 1 200 V
<b>Duration of acquisition of the reference period</b>	≤ 500 ms
<b>Duration of validity of the reference period information</b>	approximately 10 s to 50 Hz approximately 2 s to 400 Hz
<b>Duration of acquisition of the measurement period + display of the order of the phases</b>	≤ 500 ms
<b>Acceptable phase unbalance</b>	± 10°
<b>Acceptable amplitude unbalance</b>	20 %
<b>Acceptable level of harmonics in voltage</b>	10 %

### 5.3. ENVIRONMENTAL CONDITIONS

Environmental conditions	in use	in storage
Temperature	- 20°C to + 55°C	- 40°C to + 70°C
Relative humidity (RH)	≤ 90 % to 55°C	≤ 90 % up to 70°C

### 5.4. CHARACTERISTICS OF CONSTRUCTION

Housing	Rigid polycarbonate shell with moulded elastomer covering
Jaws	Polycarbonate Opening: 48 mm Clamping diameter: 48 mm
Screen	LCD display unit Blue backlighting Dimension: 41 x 48 mm
Dimension	H-272 x W-92 x D-41 mm
Weight	600 g (with the batteries)

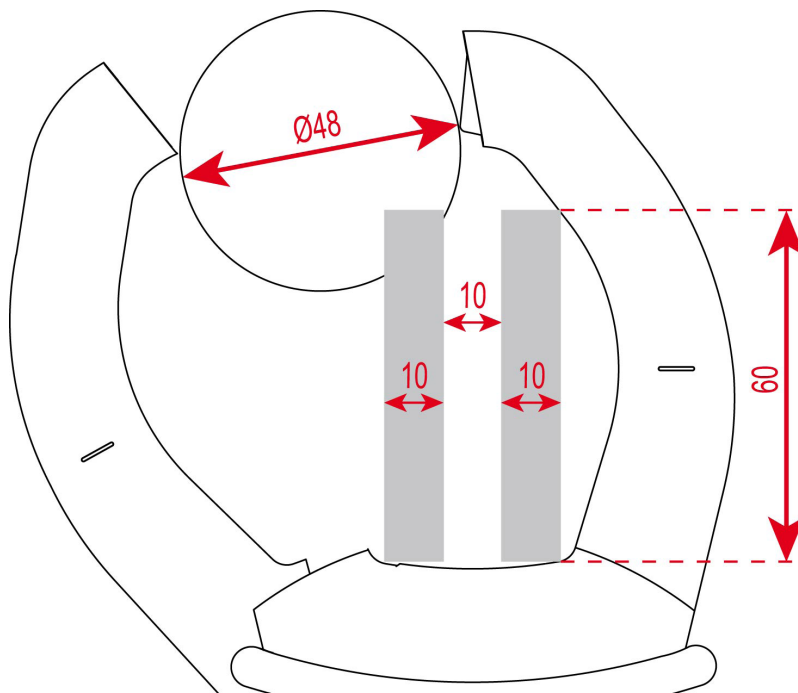

### 5.5. POWER SUPPLY



Batteries	4 x 1.5 V LR6
Mean life	> 350 hours (without backlighting)
Duration of operation before automatic switching off	After 10 minutes without action on the switch and/or keys

### 5.6. COMPLIANCE WITH INTERNATIONAL STANDARDS

Electric safety	Compliant with standards IEC/EN 61010-1, IEC/EN 61010-2-032: 1 000 V CAT IV and 1 500 V CAT III
Electromagnetic compatibility	Compliant with standard IEC/EN 61326-1** Classification: residential environment
Mechanical strength	Free fall: 2 m (in accordance with standard IEC 68-2-32)
Level of protection of the housing	Housing: IP 54 (per standard IEC/EN 60529) Jaws: IP 50 (per standard IEC/EN 60529)

**Note \*\*** : Maximum influence in mode A of ± 1 % of rated current

## 5.7. VARIATIONS IN THE DOMAIN OF USE

Quantity of influence	Range influence	Quantity influenced	Influence	
			Typical	MAX
Temperature	- 20 ... + 55°C	VAC VDC A* $\Omega$  WAC WDC	- 0.1 % R / 10°C 1 % R / 10°C* - - 0.15 % R / 10°C	0.1 % R / 10°C 0.5 % R / 10°C + 2 pts 1.5 % R / 10°C + 2 pts* 0.1 % R / 10°C + 2 pts 0.2 % R / 10°C + 1 pt 0.3 % R / 10°C + 2 pts
Humidity	10 % ... 90 %HR	V A $\Omega$  W	≤ 1 pt - 0.2 % R 0.25 % R	0.1 % R + 1 pt 0.1 % R + 2 pts 0.3 % R + 2 pts 0.5 % R + 2 pts
Frequency	10 Hz ... 1 kHz 1 kHz ... 3 kHz 10 Hz ... 400 Hz 400 Hz ... 2 kHz	V A	1 % R + 1 pt 8 % R + 1 pt 1 % R + 1 pt 4 % R + 1 pt	1 % R + 1 pt 9 % R + 1 pt 1 % R + 1 pt 5 % R + 1 pt
Position of the conductor in the jaws (f ≤ 400 Hz)	Any position on the internal perimeter of the jaws	A-W	1.5 % R	3 % R + 1 pt
Adjacent conductor carrying a current of 150 A DC or RMS	Conductor touching the external perimeter of the jaws	A-W	42 dB	35 dB
Conductor enclosed by the clamp	0-500 ADC or RMS	V	< 1 pt	1 pt
Application of a voltage of the clamp	0-1 600 VDC or RMS	A-W	< 1 pt	1 pt
Peak factor	1.4 to 3.5 limited to 1 500 A peak 1 400 V peak	A (AC-AC+DC) V (AC-AC+DC)	1 % R 1 % R	3 % R + 1 pt 3 % R + 1 pt

**Note \* in temperature:** Influence specified until 1 000 ADC

## 6. MAINTENANCE

---

The instrument has no parts that can be replaced by personnel who are not trained and approved. Any non-approved repair or other work, or replacement of a part by an "equivalent", may severely compromise safety.

### 6.1. CLEANING

- Disconnect everything connected to the device and set the switch to OFF.
- Use a soft cloth moistened with soapy water. Rinse with a damp cloth and dry quickly using a dry cloth or forced air.
- Dry perfectly before putting back into use.

### 6.2. REPLACEMENT OF THE BATTERIES

The  symbol indicates that the batteries are spent. When this symbol appears on the display unit, the batteries must be replaced. The measurements and specifications are no longer guaranteed.

To replace the batteries, proceed as follows:

1. Disconnect the measurement leads from the input terminals,
2. Set the switch to OFF,
3. Use a screwdriver to unscrew the screw securing the battery compartment cover to the back of the housing and open the cover (see § 4.1),
4. Replace all of the batteries (see § 4.1),
5. Close the cover and screw it to the housing.

## 7. WARRANTY

---

Except as otherwise stated, our warranty is valid for **3 years** starting from the date on which the equipment was sold. The extract from our General Conditions of Sale is available on our website.

[www.chauvin-arnoux.com/en/general-terms-of-sale](http://www.chauvin-arnoux.com/en/general-terms-of-sale)

The warranty does not apply in the following cases:

- Inappropriate use of the equipment or use with incompatible equipment;
- Modifications made to the equipment without the explicit permission of the manufacturer's technical staff;
- Work done on the device by a person not approved by the manufacturer;
- Adaptation to a particular application not anticipated in the definition of the equipment or not indicated in the user's manual;
- Damage caused by shocks, falls, or floods.



---

**FRANCE**

**Chauvin Arnoux**

12-16 rue Sarah Bernhardt

92600 Asnières-sur-Seine

Tél : +33 1 44 85 44 85

Fax : +33 1 46 27 73 89

[info@chauvin-arnoux.com](mailto:info@chauvin-arnoux.com)

[www.chauvin-arnoux.com](http://www.chauvin-arnoux.com)

**INTERNATIONAL**

**Chauvin Arnoux**

Tél : +33 1 44 85 44 38

Fax : +33 1 46 27 95 69

**Our international contacts**

[www.chauvin-arnoux.com/contacts](http://www.chauvin-arnoux.com/contacts)

